

TISSEL-200

Pumps with inverter

-  Clean water
-  Domestic use
-  Civil use



TS2-MK



TS2-CR



TS2-PLURIJET

DESCRIPTION

- **TISSEL 200** are compact pumping units consisting of one centrifugal waterpump coupled with a variable speed device (inverter) with an external pressure sensor to be placed in a place inside the system.
- Sturdy and simple to use, **TISSEL 200** is ideal to keep always constant pressure inside system regardless variation of utilities.
- Built-in speed regulator with automatic fan ventilation and IP54 protection. Powered by single-phase alternate tension (230±10% V - 50/60 Hz) it gives an output alternate 3phase tension to run waterpump motor in IE3 class.
- Smooth start and stop of the pump .
- Lower wear of the waterpump due to modulation of running speed from the inverter.

PROTECTIONS

- **Dry running**
Microchip action stops pump after few seconds and try scheduled set restarts to check water availability.
- **Running pressure lower than minimum set running**
It stops the pump after few seconds (i.e. when there is a break in a pipe).
- **Currents-tensions-temperatures**
It limits currents; it informs whether tension reaches the allowed limits, it protects from overheating as well as short circuits between the output phases.

CONSTRUCTION AND SAFETY STANDARDS

EN 60335-1
IEC 60335-1
CEI 61-150

EN 60034-1
IEC 60034-1
CEI 2-3



ENERGY SAVINGS

As it works at variable speed, TISSEL 200 uses only the necessary energy demand required by the system according to the water demand.

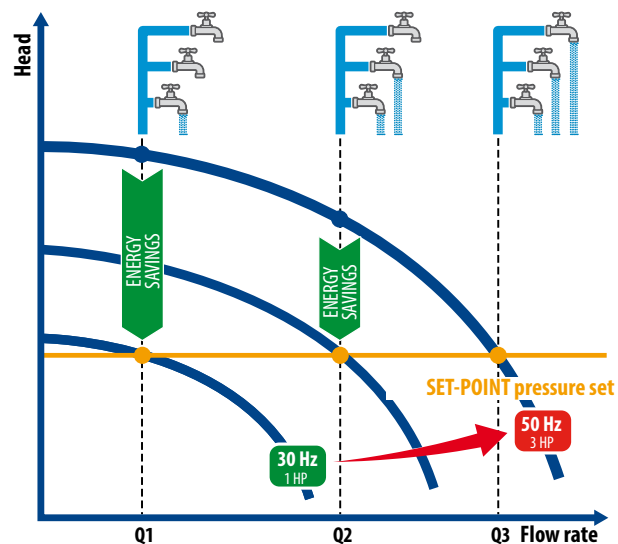

CERTIFICATIONS

Company with management system certified DNV
ISO 9001: QUALITY



TISSEL-200 MK

PERFORMANCE RANGE n= 2900 min⁻¹

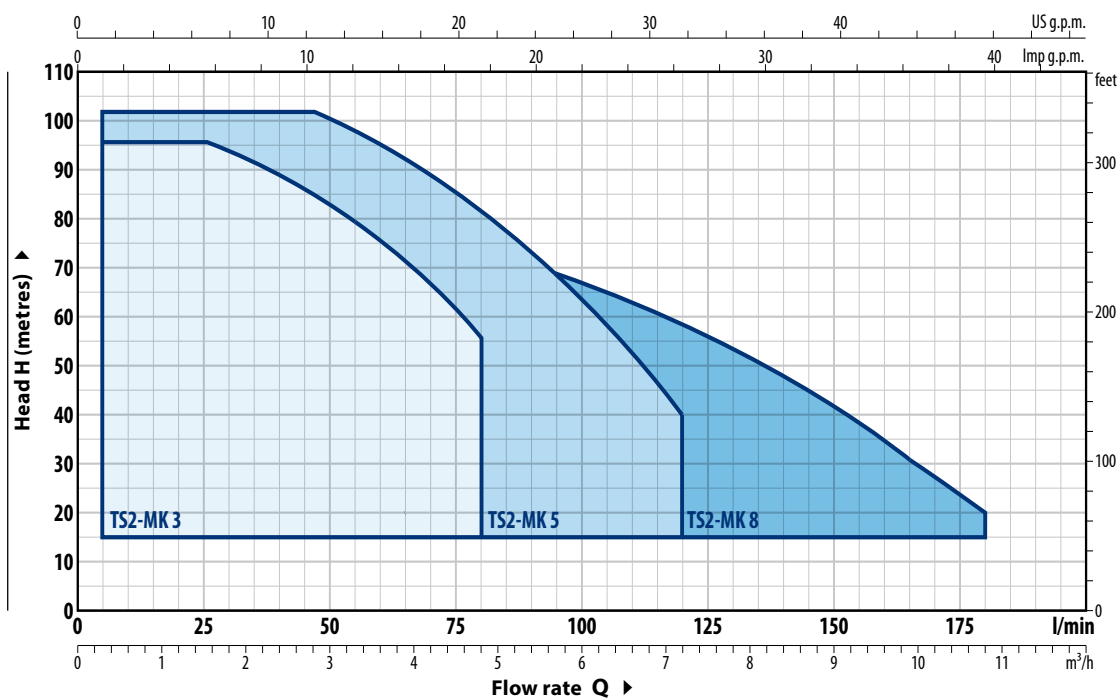

MODEL	POWER		ABSORPTION	MAX PERFORMANCES		PERFORMANCES (ADJUSTABLE SET POINT)						
	P2	▲		230 V	Q	H	Min. Set Point		Set Point Stand. Setting		Max. Set Point	
Single-phase	kW	HP		l/min	metres	bar	l/min	bar	l/min	bar	l/min	
TS2-MK 3/3	0.75	1	IE3	9.0 A	5 – 80	46 – 28	1.8	5 – 63	3.7	5 – 58	4.5	5 – 35
TS2-MK 3/4	1.1	1.5		9.0 A	5 – 80	62 – 38	2.4	5 – 62	4.9	5 – 58	6.1	5 – 33
TS2-MK 3/5	1.1	1.5		13.0 A	5 – 80	80 – 47	3.0	5 – 62	6.2	5 – 58	7.8	5 – 28
TS2-MK 3/6	1.5	2		13.0 A	5 – 80	96 – 56	3.6	5 – 63	7.4	5 – 58	9.4	5 – 25
TS2-MK 5/4	1.1	1.5		10.0 A	5 – 120	50 – 20	2.0	5 – 120	3.7	5 – 85	4.9	5 – 48
TS2-MK 5/5	1.1	1.5		12.0 A	5 – 120	63 – 25	2.5	5 – 120	4.6	5 – 85	6.2	5 – 48
TS2-MK 5/6	1.5	2		13.5 A	5 – 120	78 – 30	3.0	5 – 120	5.5	5 – 85	7.6	5 – 45
TS2-MK 5/7	1.8	2.5		16.0 A	5 – 120	92 – 34	3.5	5 – 118	6.5	5 – 85	9.0	5 – 43
TS2-MK 5/8	2.2	3		17.5 A	5 – 120	102 – 40	4.0	5 – 120	7.5	5 – 85	10.0	5 – 46
TS2-MK 8/4	1.5	2		14.0 A	5 – 180	50 – 15	2.0	5 – 167	3.7	5 – 120	4.9	5 – 70
TS2-MK 8/5	1.8	2.5		15.0 A	5 – 180	64 – 18	2.5	5 – 167	4.8	5 – 120	6.3	5 – 70
TS2-MK 8/6	2.2	3		16.0 A	5 – 180	80 – 20	3.1	5 – 163	5.5	5 – 120	7.8	5 – 53

TISSEL-200 MK

CHARACTERISTIC CURVES $n = 2900 \text{ min}^{-1}$

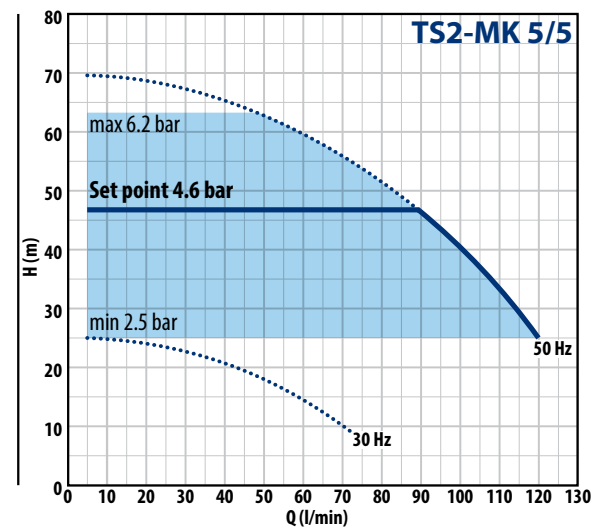
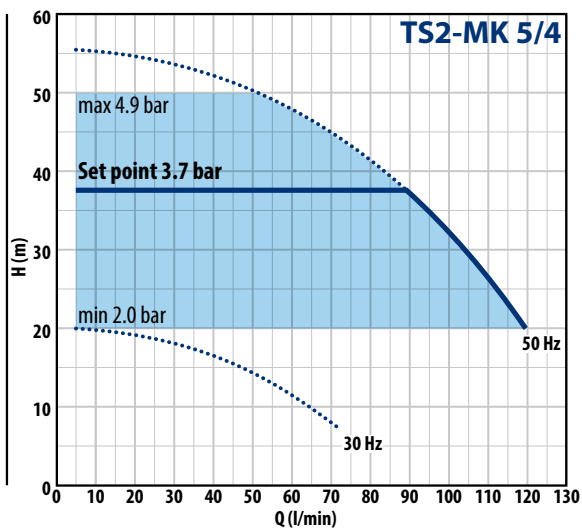
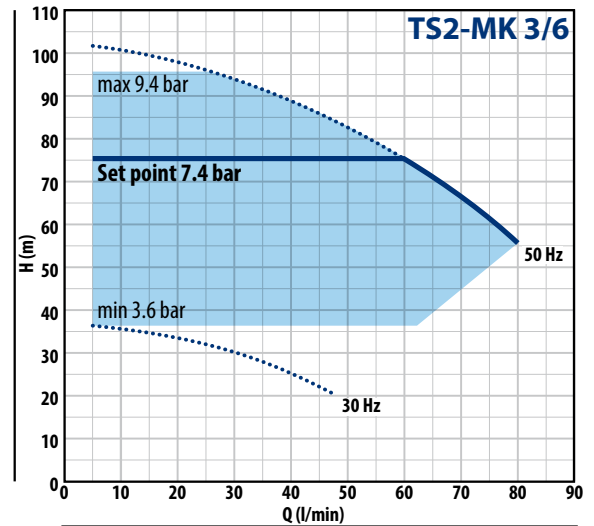
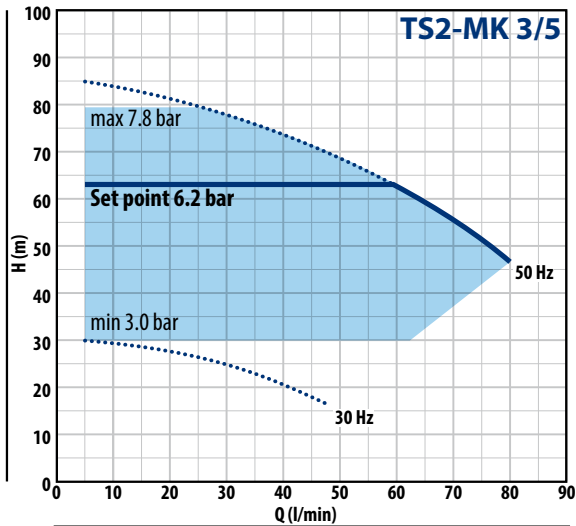
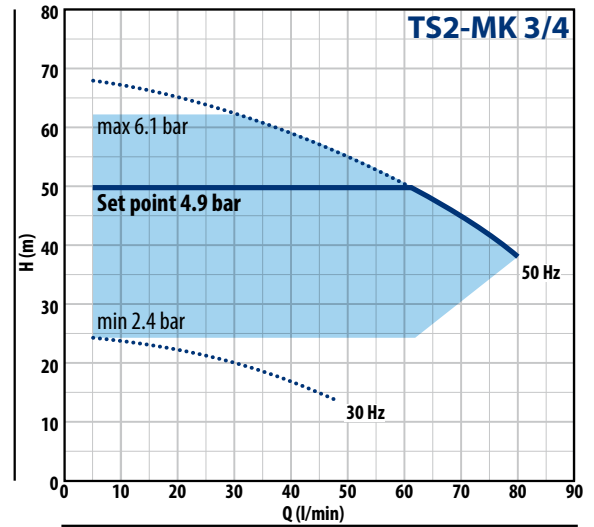
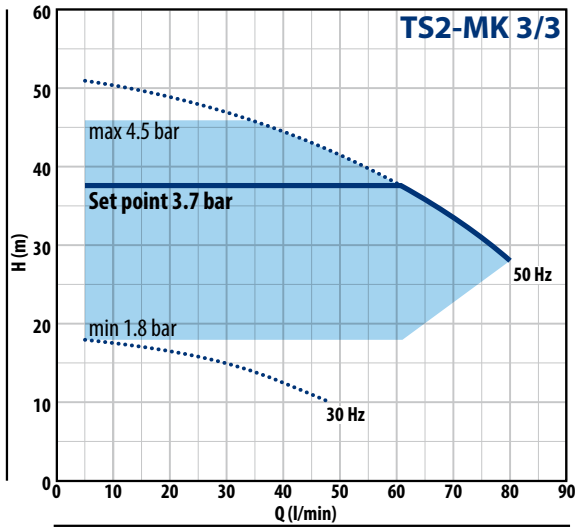

CHARACTERISTIC CURVES n= 2900 min⁻¹

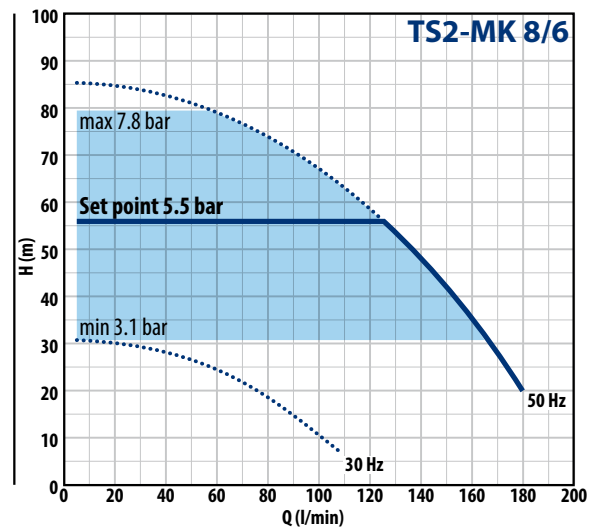
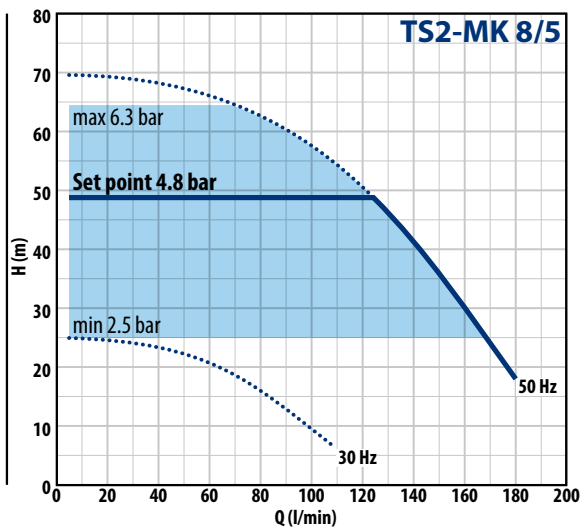
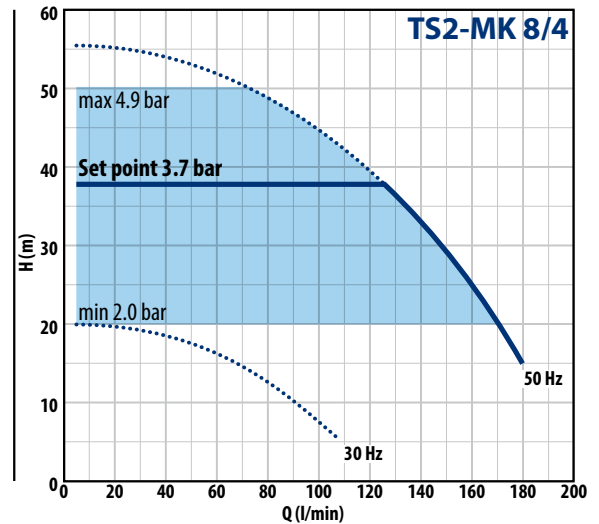
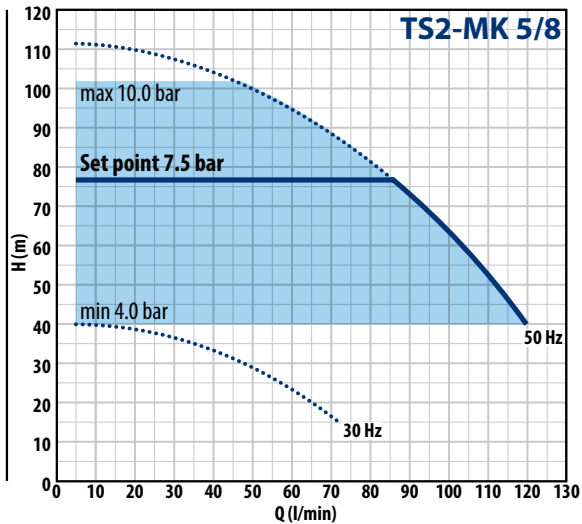
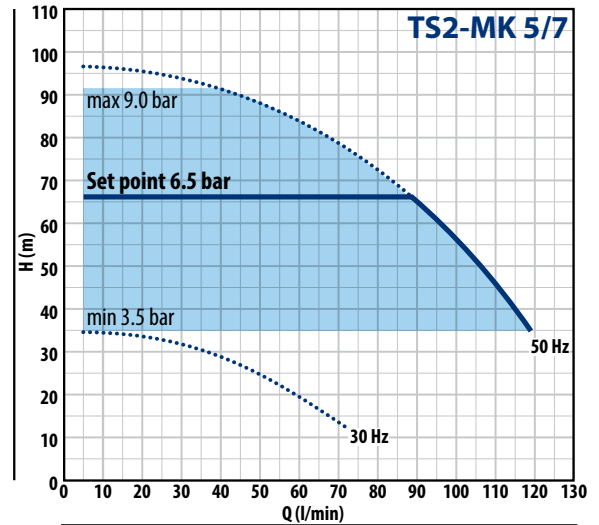
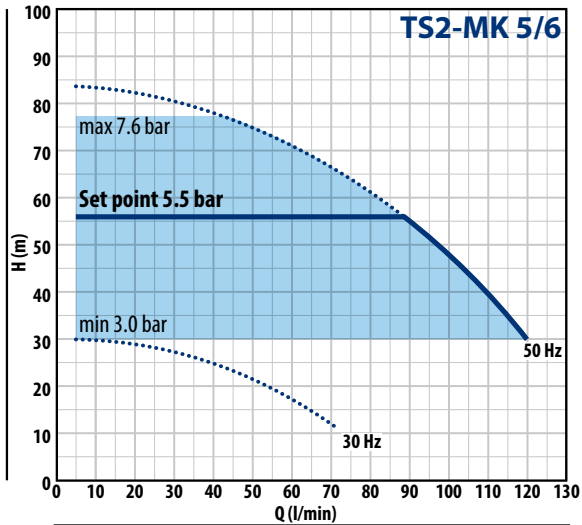

TISSEL-200 CR

CHARACTERISTIC CURVES n= 2900 min⁻¹

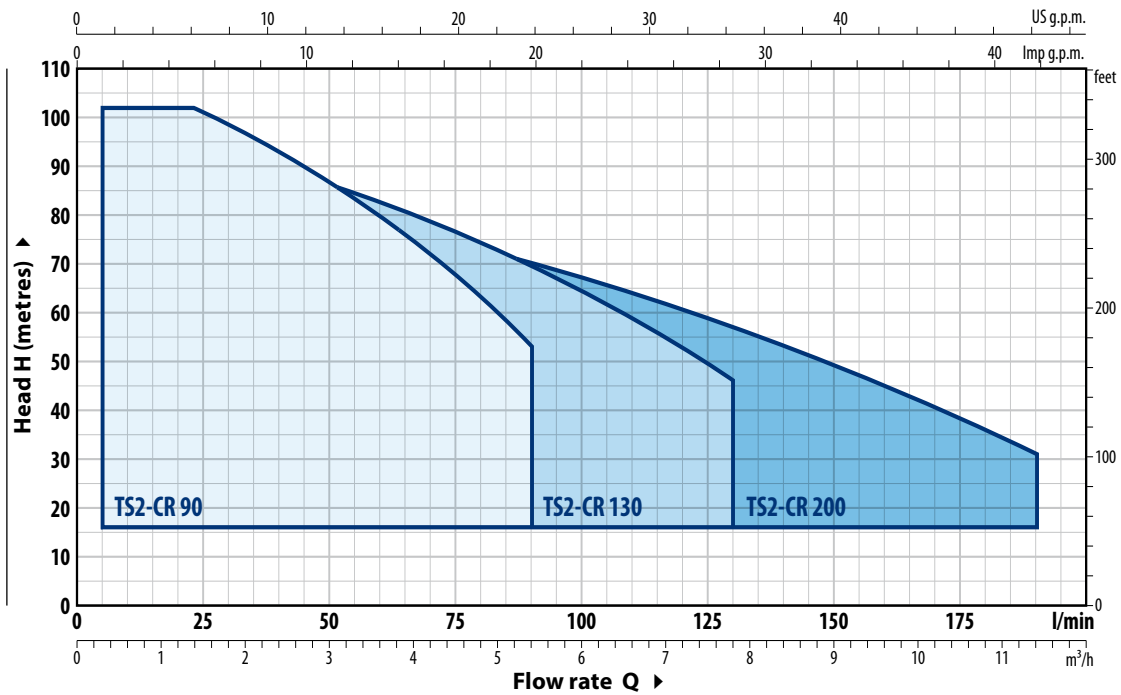

MODEL	POWER		ABSORPTION	MAX PERFORMANCES		PERFORMANCES (ADJUSTABLE SET POINT)						
	kW	HP		230 V	Q	H	Min. Set Point		Set Point Stand. Setting		Max. Set Point	
Single-phase				l/min	metres	bar	l/min	bar	l/min	bar	l/min	
TS2-5CR 90	1.1	1.5	IE3	13.0 A	5 – 90	78 – 38	2.80	5 – 75	5.30	5 – 65	7.10	5 – 23
TS2-6CR 90	1.5	2		13.5 A	5 – 90	94 – 45	3.40	5 – 75	6.30	5 – 65	8.60	5 – 21
TS2-7CR 90	1.8	2.5		16.0 A	5 – 90	110 – 53	4.00	5 – 75	7.50	5 – 65	10.00	5 – 21
TS2-3CR 130	1.1	1.5		12.5 A	5 – 130	49 – 24	1.80	5 – 110	3.40	5 – 92	4.30	5 – 48
TS2-4CR 130	1.5	2		14.5 A	5 – 130	65 – 31	2.30	5 – 110	4.40	5 – 92	5.80	5 – 45
TS2-5CR 130	1.8	2.5		18.5 A	5 – 130	81 – 39	2.90	5 – 110	5.50	5 – 92	7.40	5 – 38
TS2-6CR 130	2.2	3		20.5 A	5 – 130	97 – 45	3.50	5 – 110	6.50	5 – 92	9.00	5 – 33
TS2-3CR 200	1.1	1.5		10.0 A	5 – 200	43 – 13	1.60	5 – 185	2.80	5 – 133	3.80	5 – 72
TS2-4CR 200	1.5	2		13.0 A	5 – 200	57 – 17	2.10	5 – 185	3.60	5 – 133	5.10	5 – 65
TS2-5CR 200	1.8	2.5		16.0 A	5 – 200	72 – 22	2.60	5 – 185	4.60	5 – 133	6.50	5 – 56
TS2-6CR 200	2.2	3		22.0 A	5 – 200	86 – 26	3.10	5 – 185	5.50	5 – 133	7.90	5 – 45

CHARACTERISTIC CURVES n= 2900 min⁻¹

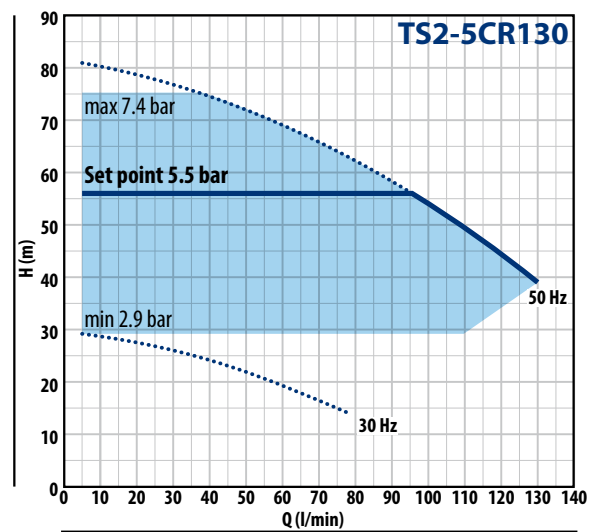
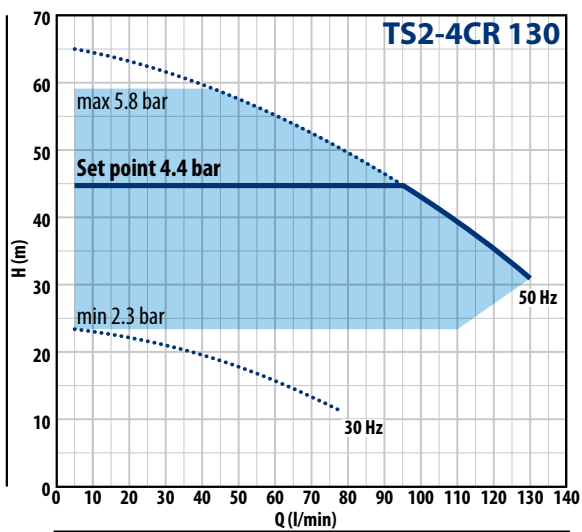
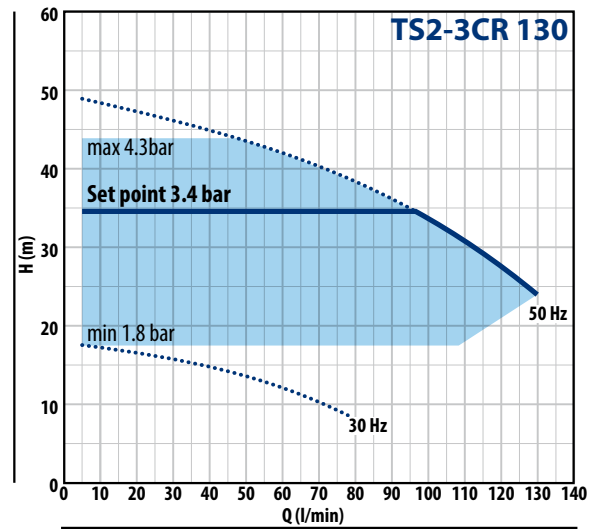
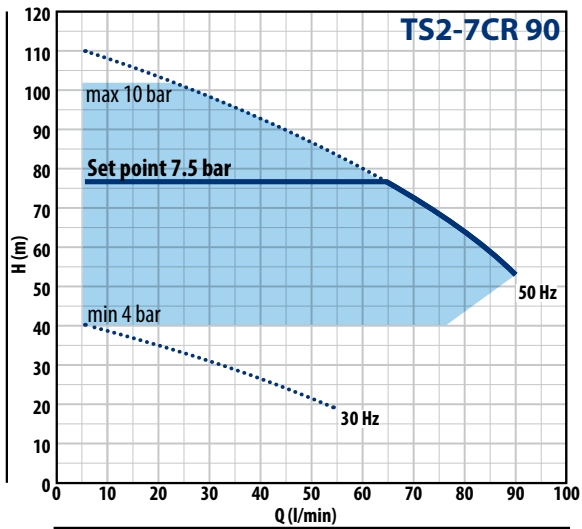
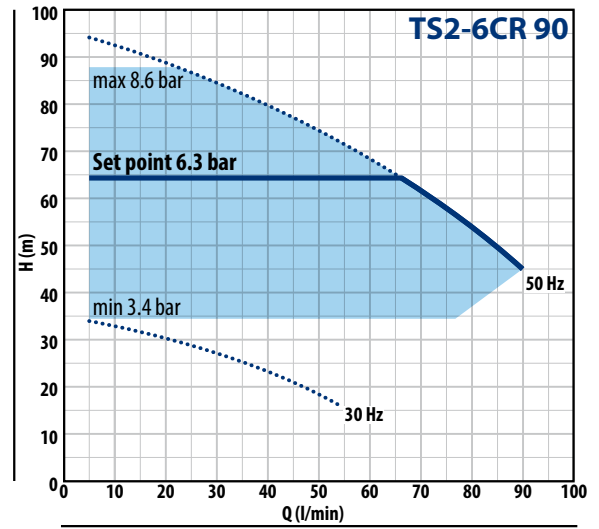
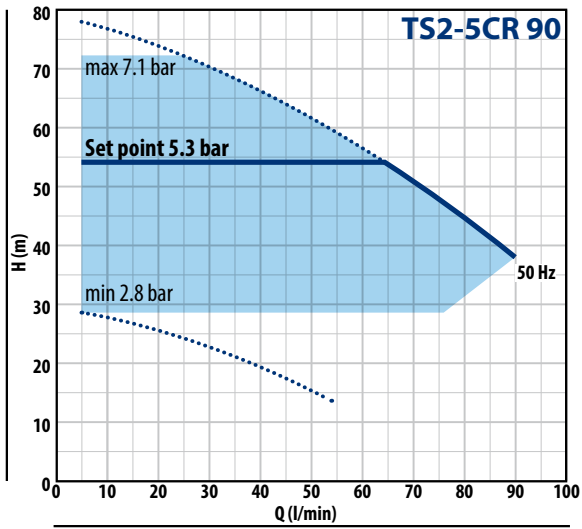

TISSEL-200 CR

CHARACTERISTIC CURVES $n = 2900 \text{ min}^{-1}$

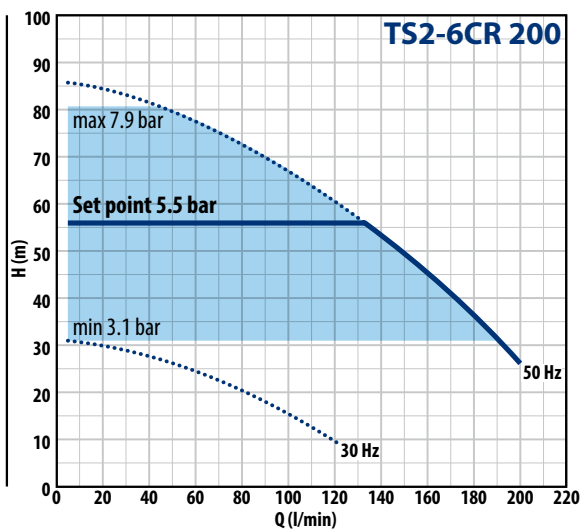
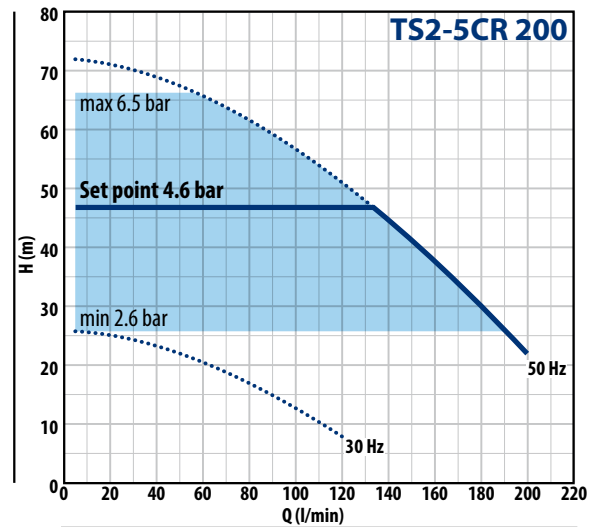
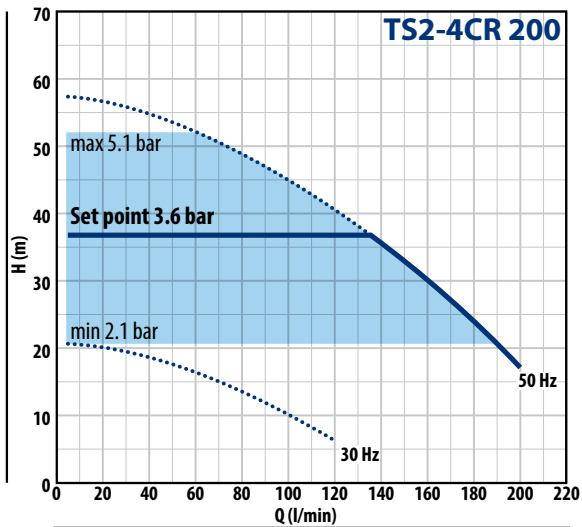
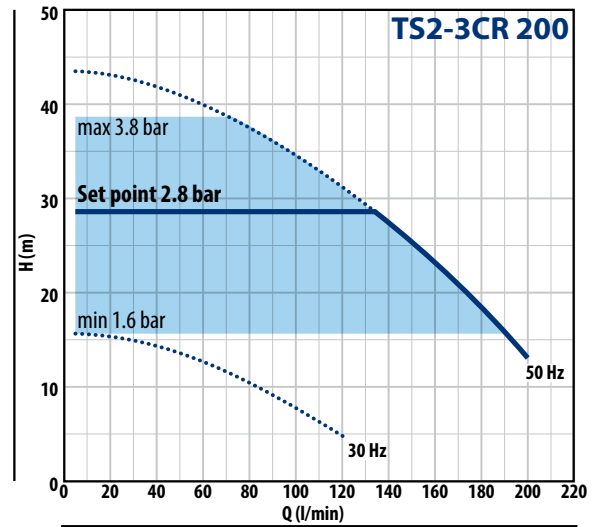
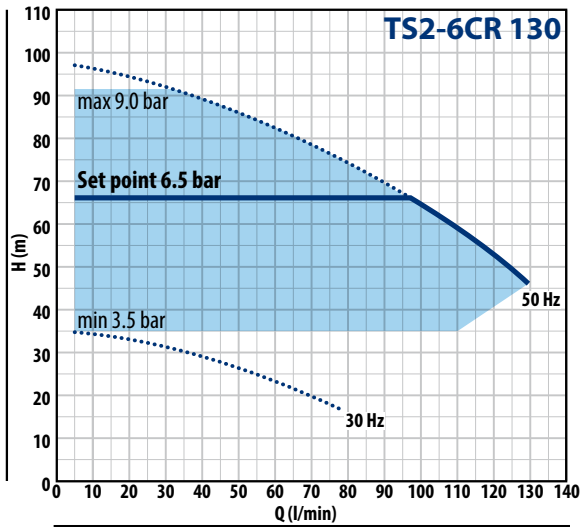

TISSSEL-200 PLURIJET

CHARACTERISTIC CURVES n= 2900 min⁻¹

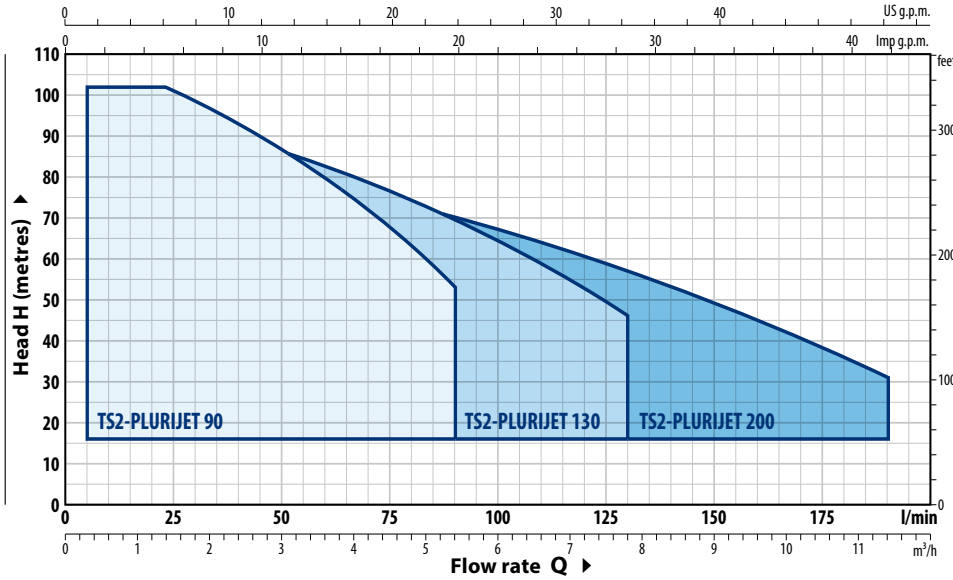

MODEL	POWER		ABSORPTION	MAX PERFORMANCES		PERFORMANCES (ADJUSTABLE SET POINT)						
	P2	▲		230 V	Q	H	Min. Set Point	Set Point Stand. Setting		Max. Set Point		
Single-phase	kW	HP		l/min	metres	bar	l/min	bar	l/min	bar	l/min	
TS2-PLURIJET 5/90	1.1	1.5	IE3	11.5 A	5 - 90	78 - 38	2.80	5 - 75	5.30	5 - 65	7.10	5 - 23
TS2-PLURIJET 6/90	1.5	2		13.5 A	5 - 90	94 - 45	3.40	5 - 75	6.30	5 - 65	8.60	5 - 21
TS2-PLURIJET 3/130	1.1	1.5		12.5 A	5 - 130	49 - 24	1.80	5 - 110	3.40	5 - 92	4.30	5 - 48
TS2-PLURIJET 4/130	1.5	2		14.5 A	5 - 130	65 - 31	2.30	5 - 110	4.40	5 - 92	5.80	5 - 45
TS2-PLURIJET 5/130	1.8	2.5		18.5 A	5 - 130	81 - 39	2.90	5 - 110	5.50	5 - 92	7.40	5 - 38
TS2-PLURIJET 6/130	2.2	3		20.0 A	5 - 130	97 - 45	3.50	5 - 110	6.50	5 - 92	9.00	5 - 33
TS2-PLURIJET 3/200	1.1	1.5		10.0 A	5 - 200	43 - 13	1.60	5 - 185	2.80	5 - 133	3.80	5 - 72
TS2-PLURIJET 4/200	1.5	2		16.0 A	5 - 200	57 - 17	2.10	5 - 185	3.60	5 - 133	5.10	5 - 65
TS2-PLURIJET 5/200	1.8	2.5		16.0 A	5 - 200	72 - 22	2.60	5 - 185	4.60	5 - 133	6.50	5 - 56
TS2-PLURIJET 6/200	2.2	3		22.0 A	5 - 200	86 - 26	3.10	5 - 185	5.50	5 - 133	7.90	5 - 45

CHARACTERISTIC CURVES n= 2900 min⁻¹

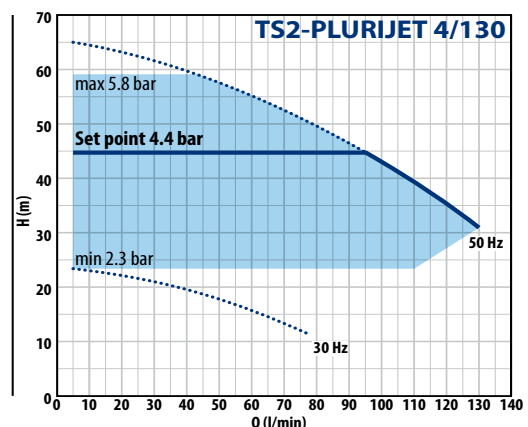
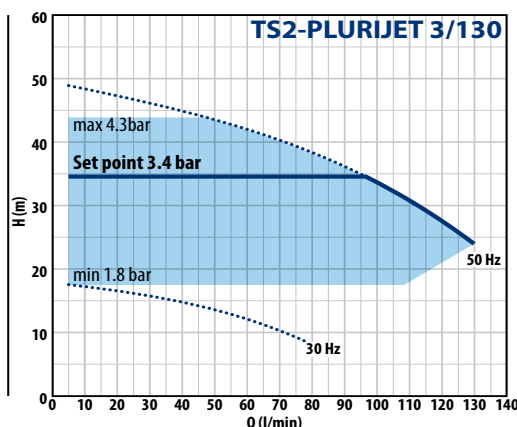
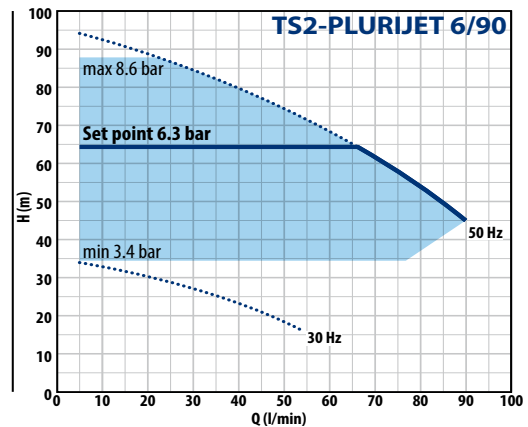
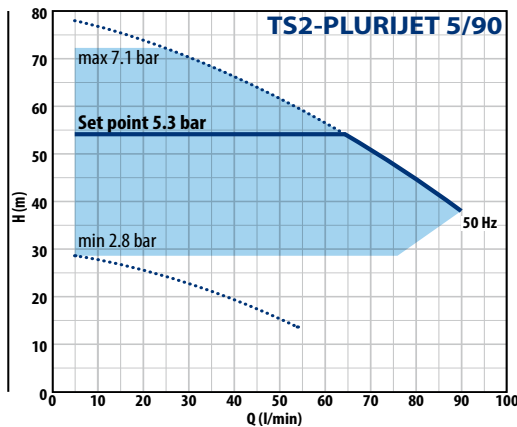

TISSEL-200 PLURIJET

CHARACTERISTIC CURVES $n = 2900 \text{ min}^{-1}$

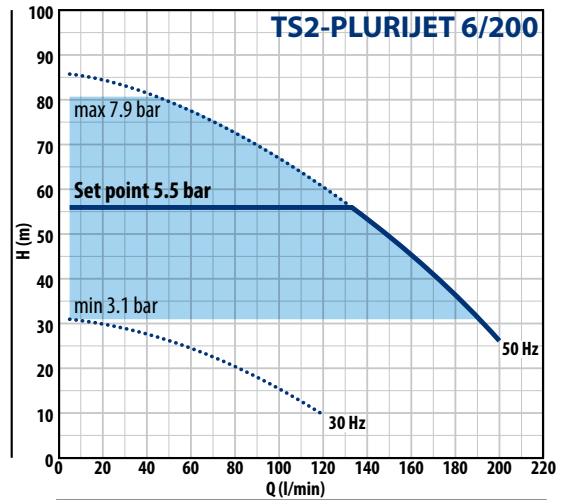
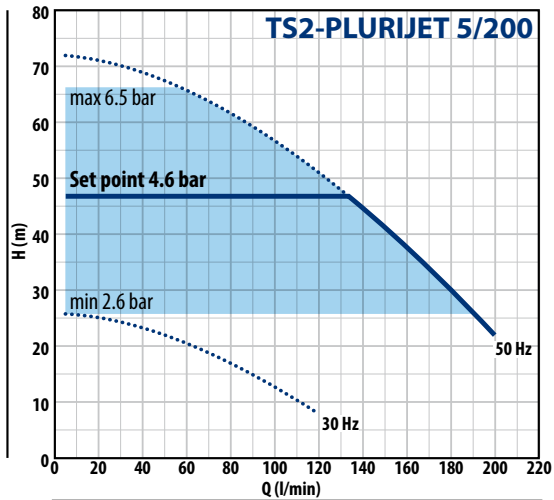
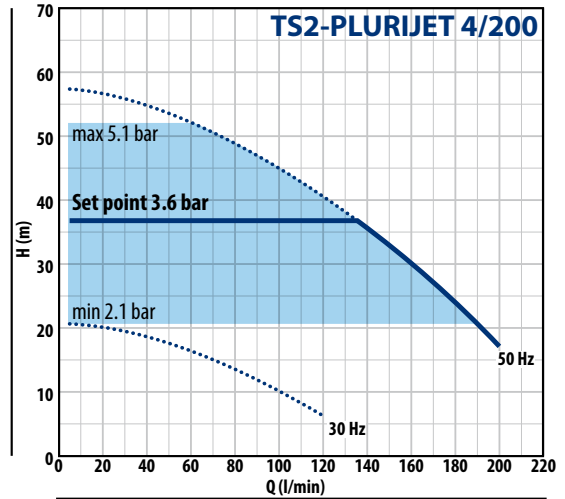
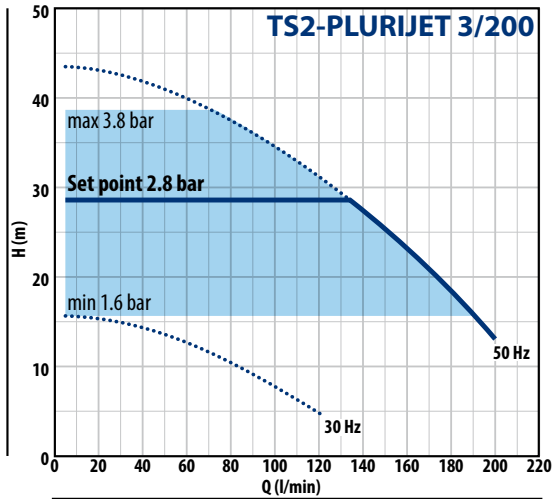
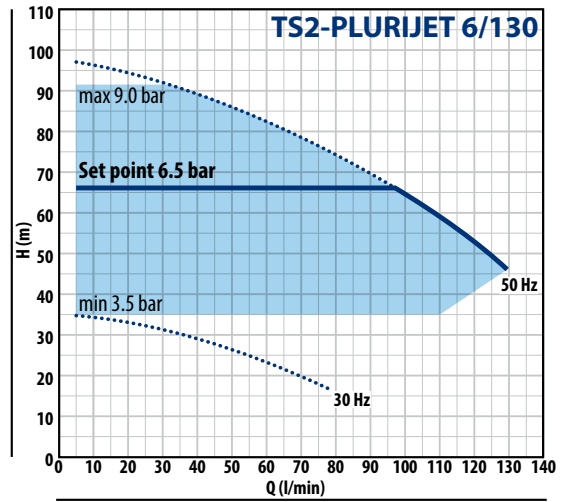
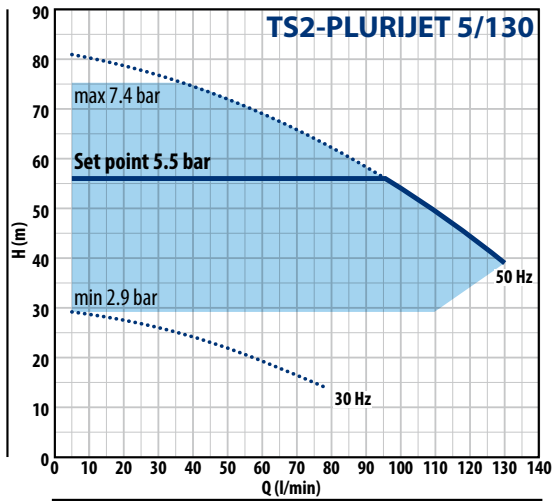

DIMENSIONS (mm)

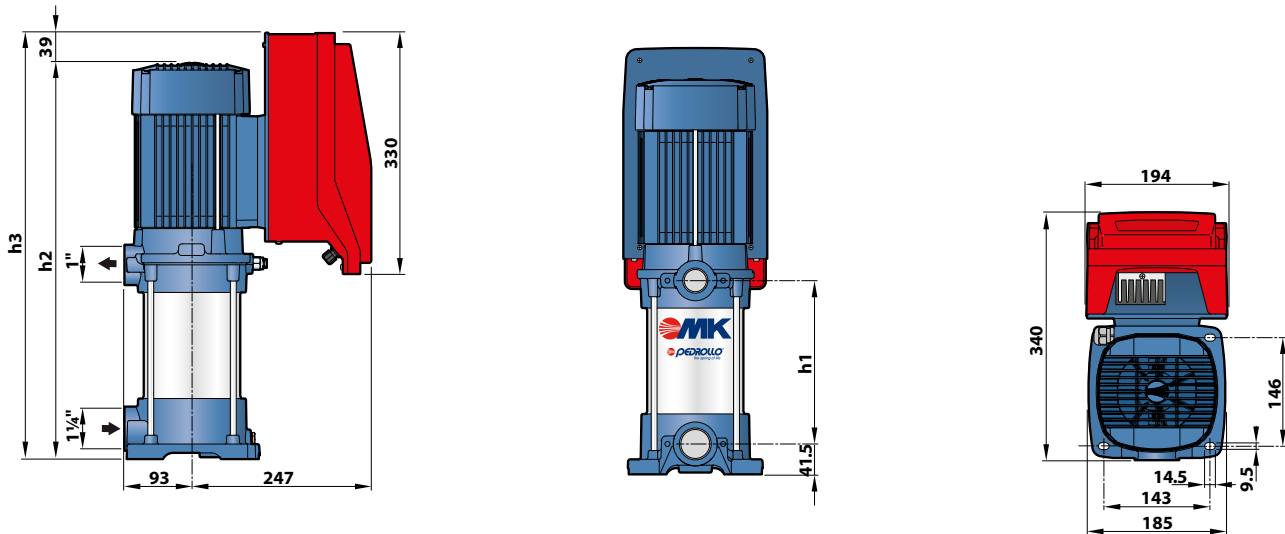

MODEL	h1	h2	h3	kg
TS2-MK 3/3	132.5	450	489	26.7
TS2-MK 3/4	159.5	477	516	27.0
TS2-MK 3/5	186.5	504	543	28.6
TS2-MK 3/6	213.5	531	570	30.1
TS2-MK 5/4	159.5	477	516	26.9
TS2-MK 5/5	186.5	504	543	28.5
TS2-MK 5/6	213.5	531	570	30.3
TS2-MK 5/7	240.5	558	597	30.7
TS2-MK 5/8	267.5	585	624	30.9
TS2-MK 8/4	159.5	477	516	28.0
TS2-MK 8/5	186.5	504	543	29.6
TS2-MK 8/6	213.5	531	570	30.4

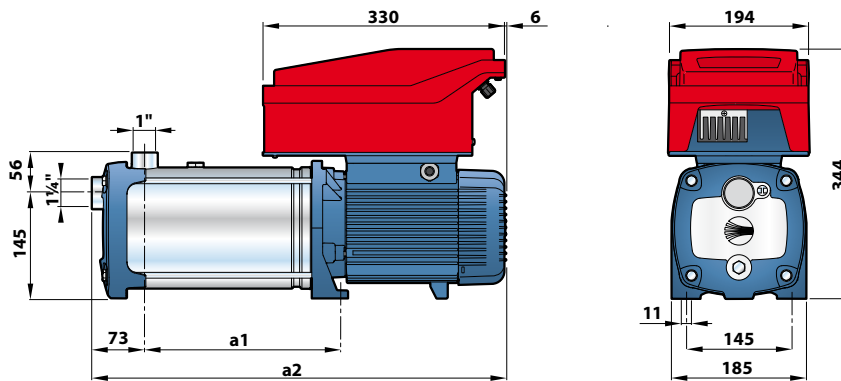

MODEL	a1	a2	kg
TS2-5CR 90	193	497	26.3
TS2-6CR 90	219	523	28.4
TS2-7CR 90	245	569	32.5
TS2-3CR 130	141	445	25.0
TS2-4CR 130	167	471	26.9
TS2-5CR 130	193	517	30.3
TS2-6CR 130	219	543	31.2
TS2-3CR 200	141	445	25.0
TS2-4CR 200	167	471	26.9
TS2-5CR 200	193	517	30.3
TS2-6CR 200	219	543	31.2

MODEL	a1	a2	kg
TS2-PLURIJET 5/90	245	549	27.0
TS2-PLURIJET 6/90	271	575	29.0
TS2-PLURIJET 3/130	193	497	25.1
TS2-PLURIJET 4/130	219	523	27.1
TS2-PLURIJET 5/130	245	569	30.7
TS2-PLURIJET 6/130	271	595	31.8
TS2-PLURIJET 3/200	193	497	25.1
TS2-PLURIJET 4/200	219	523	27.1
TS2-PLURIJET 5/200	245	569	30.7
TS2-PLURIJET 6/200	271	595	31.8